

Instant™

VORTEX™ MINI

2 QUART AIR FRYER



User manual

- Important safeguards
- Product, parts and accessories
- Get started
- Control panel
- Cooking
- Care, cleaning and storage
- Troubleshooting
- Warranty
- Contact

Download the Instant Pot app with
1000+ recipes at instantappliances.com/app.

IMPORTANT SAFEGUARDS

(Yes, we have to)

At Instant Brands™ your safety always comes first. The Instant™ Vortex™ family was designed with your safety in mind, and we mean business. Visit instantappliances.com to learn about this appliance's safety mechanisms.

When using electrical appliances, basic safety precautions should always be followed:

- 01** READ ALL INSTRUCTIONS, SAFEGUARDS, AND WARNINGS BEFORE OPERATING THE APPLIANCE. FAILURE TO FOLLOW THESE SAFEGUARDS AND INSTRUCTIONS MAY RESULT IN INJURY AND/OR PROPERTY DAMAGE.
- 02** The appliance's outer surfaces may become hot during use. DO NOT touch hot surfaces. Only use the air fryer basket handle to lift and carry the air fryer basket. Wear proper hand protection when handling hot components. Extreme caution must be used when moving the appliance. Let the appliance cool to room temperature before handling or moving.
- 03** **⚠ CAUTION** To protect against the risk of electrical shock, DO NOT immerse power cord, plug, or the appliance in water or other liquid.
- 04** DO NOT rinse the appliance under tap.
- 05** The cooking chamber contains electrical components. To avoid electrical shock, DO NOT put liquid of any kind into the cooking chamber.
- 06** This appliance is NOT to be used by children or by persons with reduced physical, sensory, or mental capabilities. Close supervision is necessary when this appliance is used near children and these individuals. Children should not use or play with this appliance.
- 07** Turn off and unplug when not in use, as well as before adding or removing parts or accessories, and before cleaning. To turn off, press **Cancel**. To unplug, grasp the plug and pull from the outlet. NEVER pull from the power cord.
- 08** Avoid making contact with moving parts.
- 09** Inspect the appliance and power cord regularly. DO NOT operate any appliance with a damaged cord or plug or after the appliance malfunctions, or is dropped or damaged in any manner. For assistance, contact the Customer Care Team at support@instantappliances.com or **1-800-828-7280**.

⚠ WARNING

Read this manual carefully and completely and retain for future reference. Failure to adhere to safety instructions may result in serious injury or damage.

IMPORTANT SAFEGUARDS

- 10 DO NOT use any accessories or attachments not authorized by Instant Brands Inc. The use of attachments not recommended by the manufacturer, may cause a risk of injury, fire or electric shock.
- 11 For household countertop use only. DO NOT use outdoors. Not for commercial use.
- 12 DO NOT place the appliance on any kind of stovetop, or in a heated oven; heat from an external source will damage the appliance.
- 13 DO NOT let power cord contact hot surfaces or open flame, including a stovetop.
- 14 DO NOT use appliance for anything other than intended use.
- 15 Proper maintenance is recommended after each use. Refer to **Care, cleaning and storage**. Let the appliance cool to room temperature before cleaning or storage.
- 16 **⚠ CAUTION** Spilled food can cause serious burns. A short power-supply cord is provided to reduce the hazards resulting from grabbing, entanglement and tripping. Keep appliance and cord away from children. NEVER drape cord over edge of table or counter, NEVER use power outlet below counter, and NEVER use with an extension cord.
- 17 DO NOT attempt to repair, replace, alter, or modify components of the appliance. This may cause electric shock, fire and/or injury, and will void the warranty.
- 18 DO NOT tamper with any of the safety mechanisms.
- 19 DO NOT use the appliance in electrical systems other than 120 V ~ 60 Hz. DO NOT use with power converters or adapters.
- 20 DO NOT overfill the appliance or accessories. Overfilling may cause food to contact the heating element, which may result in fire and/or personal injury.
- 21 DO NOT cover the cooling vents while the appliance is in operation. Doing so will prevent even cooking and may cause damage to the appliance.
- 22 NEVER pour oil into the cooking chamber. This could result in fire and/or personal injury.

⚠ WARNING

Read this manual carefully and completely and retain for future reference. Failure to adhere to safety instructions may result in serious injury or damage.

IMPORTANT SAFEGUARDS

- 23 While cooking, the internal temperature of the appliance reaches several hundred degrees. To avoid personal injury, NEVER place unprotected hands inside the appliance until it has cooled to room temperature.
- 24 When cooking, DO NOT place the appliance against a wall or against other appliances. Leave at least 5" / 13 cm of free space on the back, sides, and above the appliance. DO NOT operate the appliance on or near combustible materials such as tablecloths and curtains. DO NOT place anything on top of the appliance.
- 25 When in operation, hot air is released through the cooling vents. Keep your hands and face at a safe distance from the cooling vents and take extreme caution when removing the accessories from the appliance.
- 26 Should the unit emit black smoke, press **Cancel** and unplug the appliance immediately. Wait for smoking to stop before removing the air fryer basket, then clean the appliance thoroughly.
- 27 DO NOT leave the appliance unattended while in use.
- 28 NEVER connect this appliance to an external timer switch or separate remote-control system.
- 29 Use extreme caution when removing hot accessories from the cooking chamber or disposing of hot grease.
- 30 Oversized foods and/or metal utensils must not be inserted into the cooking chamber as they may cause risk of fire and/or personal injury.
- 31 DO NOT store any materials, other than the included accessories, in the cooking chamber when not in use.
- 32 DO NOT place any combustible materials in the cooking chamber, such as paper, cardboard, plastic, Styrofoam or wood.
- 33 DO NOT use appliance accessories in any other appliance including microwave ovens, toaster ovens, convection or conventional ovens, ceramic, electric, induction or gas cooktops, or outdoor grills.
- 34 **⚠ CAUTION** Use extreme caution when moving an appliance containing hot oil or other hot liquids.

SAVE THESE INSTRUCTIONS.

⚠ WARNING

Read this manual carefully and completely and retain for future reference. Failure to adhere to safety instructions may result in serious injury or damage.

IMPORTANT SAFEGUARDS

⚠ WARNING

To avoid injury, read and understand the instructions in this user manual before attempting to use this appliance.

⚠ WARNING

Electrical shock hazard. Use grounded outlet only.

- DO NOT remove ground.
- DO NOT use an adapter.
- DO NOT use an extension cord.

Failure to follow these instructions may result in electric shock and/or serious injury.

⚠ WARNING







THE FAILURE TO FOLLOW ANY OF THE IMPORTANT SAFEGUARDS AND/OR THE INSTRUCTIONS FOR SAFE USE IS A MISUSE OF YOUR APPLIANCE THAT CAN VOID YOUR WARRANTY AND CREATE THE RISK OF SERIOUS INJURY.

Special cord set instructions

As per safety requirements, a short power supply cord (0.6 m to 0.9 m / 24" to 35") is provided to reduce the hazards resulting from grabbing, entanglement and tripping.

This appliance has a 3-prong grounding plug. To reduce the risk of electric shock, plug the power cord into a grounded (earthed) electrical outlet that is easily accessible.

Product specifications

					
Models: Vortex Mini RE Vortex Mini AQ Vortex Mini BL Vortex Mini WH	1300 W	120 V ~ 60 Hz	2 Quart	7.28 lb/ 3.3 kg	in: 11.26D x 9.02W x 11.73H cm: 28.6D x 22.9W x 29.8H

Find your model name and serial number

Find both of these on the rating label on the back of the air fryer, near the power cord.

⚠ WARNING

Read this manual carefully and completely and retain for future reference.
Failure to adhere to safety instructions may result in serious injury or damage.

Table of contents

IMPORTANT SAFEGUARDS	2
Special cord set instructions.....	5
Product specifications	5
Find your model name and serial number	5
Product, parts and accessories	7
Get started	8
Initial set up.....	8
Initial test run	9
Control Panel	10
Settings.....	11
Cooking status.....	12
Status messages.....	12
Cooking	13
Air Fry, Roast and Bake.....	13
Cooking tips	15
Reheat.....	16
Care, cleaning and storage	17
Troubleshooting	18
Warranty	19
Contact	21

Product, parts and accessories

Before using your cute new air fryer, make sure that everything is present and accounted for.

Air fryer

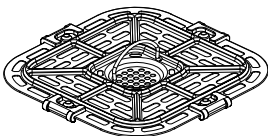
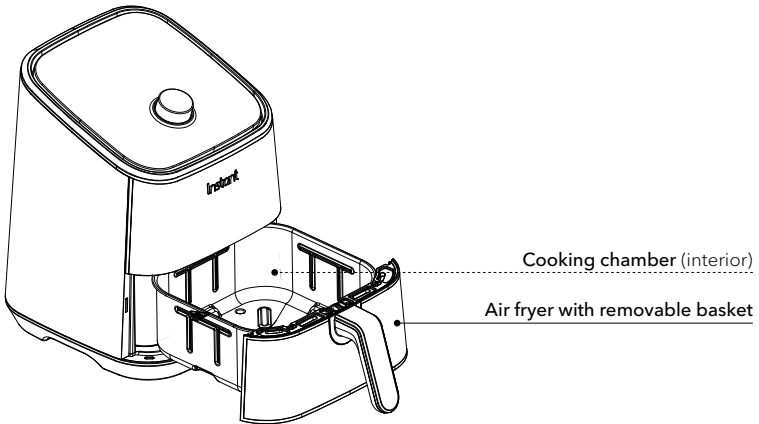
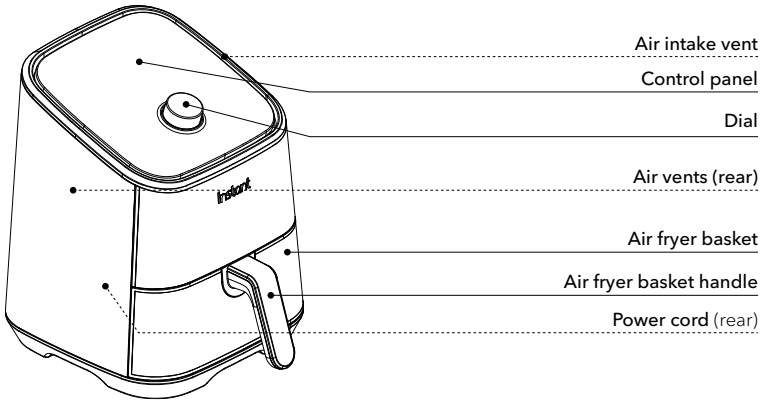

Cooking tray

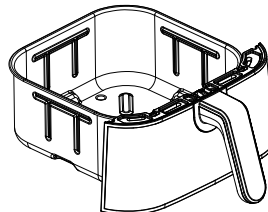

Air fryer basket



*Illustrations in this document are for reference only and may differ from the actual product.
Always refer to the actual product.*

Get started

Initial set up



"Notice the small things. The rewards are inversely proportional." - Liz Vassey

- 01** Pull that Vortex Mini out of the box!
- 02** Remove the air fryer basket and check the cooking chamber for loose packing material before first use.
 -  Don't remove the silicone supports from the removable cooking tray.
- 03** You may be tempted to put the air fryer on your stovetop – *but don't do it!* Place it on a stable, level surface, *away* from combustible material and external heat sources. Do not place your air fryer on top of another appliance.
 -  Make sure to leave *at least* 13 cm / 5" of space above and around all sides of the appliance.
- 04** Follow the **Care, cleaning and storage** instructions to wash your new air fryer before using it.
 -  Don't remove the safety warning stickers or the rating label from the air fryer.

Is something missing or damaged?

Get in touch with a Customer Care Advisor through our chat widget at instantappliances.com/#chat, by email at support@instantappliances.com or by phone at **1-800-828-7280** and we'll happily make some magic happen for you!

⚠ WARNING



<p>Read the Important Safeguards before using the appliance. Failure to read and follow those instructions for safe use may result in damage to the appliance, property damage or personal injury.</p>	<p>Do not place the appliance on a stovetop, on another appliance, or in a heated oven. Heat from an external source will damage the appliance.</p>	<p>To avoid the risk of fire, property damage, and/or personal injury, do not place anything on top of the appliance, and do not block the air vents.</p>
---	---	---

Get started



Initial test run

Do you *have* to do the test run? No – but getting to know the ins and outs of your Vortex Mini prepares you for success in the kitchen! Take a few minutes to get to know how this little guy works.

Stage 1: Setting up the air fryer for cooking

- 01** Connect the power cord to a 120 V power source.
The air fryer is in standby mode and the display shows **OFF**.
- 02** Remove the air fryer basket from the cooking chamber.
- 03** Place the cooking tray on the bottom of the air fryer basket (if it is not already installed).
- 04** Insert the air fryer basket back into the cooking chamber.
- 05** Touch **Air Fry**.
- 06** Touch **Time**, then turn the dial to adjust the cook time to 20 minutes (**00:20**).
 Each Smart Program automatically saves the adjustments you make to the time and temperature when you touch **Start**.
- 07** Touch **Start** to begin!
The display shows **On** and the cooking status shows **Preheat**.
 The first few times you use your air fryer, you may notice a strong plastic smell. This is normal, non-toxic, and goes away quickly.

Stage 2: "Cooking" (...but not really, this is just a test!)

- 01** When the air fryer is hot enough, the display shows **Add Food**.
 For this initial test, do not add food to the air fryer basket.
Carefully remove and re-insert the air fryer basket. The display shows the cooking time and temperature, and the cooking status shows **Cook**.
- 02** Part way through cooking, the display shows **turn Food**.
Wait 10 seconds for the program to resume automatically, or, remove and re-insert the air fryer basket to pause and resume the program manually.
- 03** When 1 minute remains, the display counts down the remaining cooking time in seconds.
When the Smart Program completes, the display shows **End** and the fan blows for a little while to help cool the air fryer.
- 04** Press the dial or remove and re-insert the air fryer basket to return to standby mode and start cooking for real!
 If you forget this last step, the air fryer will beep to remind you about it after 5, 30, and 60 minutes.

CAUTION

The air fryer and air fryer basket will be hot during and after cooking. To avoid the risk of burn injury, DO NOT touch hot surfaces. Allow the air fryer to cool to room temperature, then clean the appliance according to **Care, cleaning and storage** instructions.

Control panel

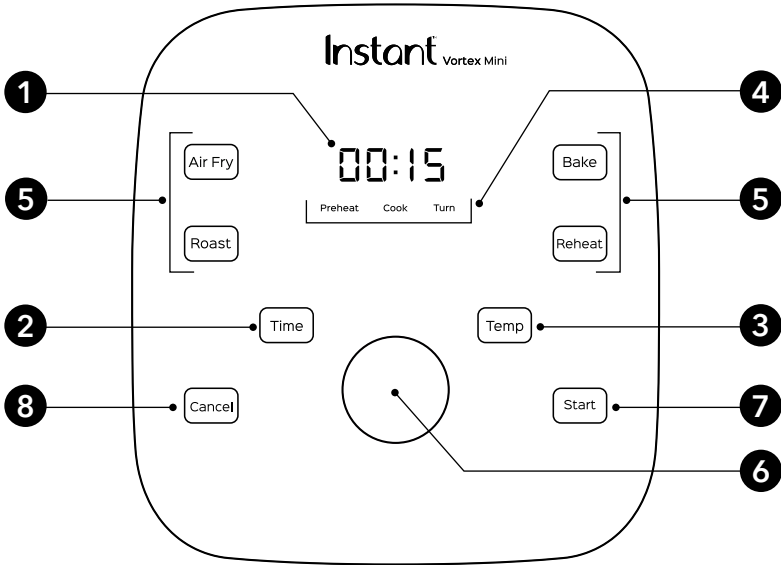

1	Time/temperature display	Shows the cooking time, the set temperature, reminder messages and error messages.
2	Time	Touch Time if you want to adjust the cooking time.
3	Temp	Touch Temp if you want to adjust the cooking temperature.
4	Cooking status	Preheat, Cook and Turn.
5	Smart programs	<ul style="list-style-type: none"> • Air Fry • Roast • Bake • Reheat
6	Dial	Rotate to adjust cooking times and temperatures. Press to wake the display.
7	Start	Touch Start to begin a selected smart program.
8	Cancel	Touch Cancel to stop a smart program at any time and go back to standby.

*Illustrations in this document are for reference only and may differ from the actual product.
Always refer to the actual product.*

Settings

To do this...	Do this!
Wake the air fryer.	Touch any button, press the dial, or remove and re-insert the air fryer basket to wake the air fryer. The display shows OFF to let you know that it's in standby mode and ready for action.
Turn sounds on and off.	In standby mode, touch and hold both the Time and Temp for 3 seconds. The display shows S On when the sound is on, and SOFF when the sound is off.  Error alerts cannot be silenced.
Change temperature scale (°C or °F).	In standby mode, touch and hold the Temp key for 5 seconds to toggle between °C and °F .
Save a custom cooking time.	Select a smart program, then touch Time , and use the dial to adjust the time as you like. Touch Start to save the change to memory.
Reset an individual smart program.	In standby mode, touch and hold the smart program key you want to reset (for example: Air Fry) for 3 seconds. The cooking time and temperature for that Smart Program are restored to the factory default settings.
Reset all smart programs.	In standby mode, press and hold the dial for 3 seconds. The cooking times and temperatures for all Smart Programs are restored to the factory default settings.

Cooking status

00:15

Preheat

Cook

Turn

The air fryer is heating up to the perfect temperature to cook your meal.



 Not applicable to Reheat.

Cooking is in progress.

Food is ready to be flipped or tossed, as required by your recipe.

 Not applicable to Bake or Reheat.

Status messages

OFF	The air fryer is in standby mode.
On	A smart program is in the Preheat stage.  Not applicable to Reheat.
Add Food	This message appears to let you know that the air fryer has reached the perfect cooking temperature and food can be added to the air fryer basket (if it hasn't been already).  Not applicable to Reheat.
OPEN	May indicate that the air fryer basket has been removed or is not fully inserted.
05:20	The display shows the cooking time, and on-screen messages.
Turn Food	Food is ready to be turned or tossed, as recommended by your recipe.  Not applicable to Bake or Reheat.
End	The Smart Program has finished.

Cooking

Cooking in the Vortex is quick and easy – food goes in, crispy deliciousness comes out!

Check out the **cooking timetables** for guidance, or visit our **recipe site** for fun, easy-to-follow recipes with big crunch. You can also download the free **Instant Pot app** to search recipes, save favorites, make notes and more!

⚠ CAUTION

When cooking meat, always use a meat thermometer to ensure the internal temperature reaches a safe minimum temperature. Refer to the USDA's **Safe Minimum Internal Temperature Chart** or Health Canada's **Cooking Temperatures Chart** for more information.

Air Fry, Roast and Bake

These programs give your meals all the rich, crispy flavor of deep frying with little to no oil, so you can say, "See ya!" to the greasy mess and extra calories! The presets are a starting point that you can experiment with to get the results you like best.

Smart program	Default time	Time range	Default temperature	Temperature range
Air Fry	12 minutes (00:12)	1 minute to 1 hour (00:01 to 01:00)	205°C / 400°F	82 to 205°C 180 to 400°F
Roast	18 minutes (00:18)	1 minute to 1 hour (00:01 to 01:00)	193°C / 380°F	82 to 205°C 180 to 400°F
Bake	30 minutes (00:30)	1 minute to 1 hour (00:01 to 01:00)	166°C / 330°F	82 to 205°C 180 to 400°F

Stage 1: Setting up for cooking

- 01 Follow steps 01 to 04 in the **Initial test run: Stage 1** to set up the air fryer.
- 02 Touch the smart program you want to use: **Air Fry**, **Roast** or **Bake**.
- 03 Touch **Temp**, then turn the dial to adjust the temperature.

- 04 Touch **Time**, then turn the dial to adjust the time.

 Smart Programs automatically save adjustments to temperature and time settings when you touch **Start**.

- 05 Touch **Start** to begin!
The display shows **On** and the cooking status shows **Preheat**.

Cooking

Stage 2: Cooking

01 When the display shows **Add Food**, remove the air fryer basket and carefully place your food items inside the hot cooking chamber.

 You can put food directly on the cooking tray or within any oven-safe baking dish.

02 Carefully re-insert the air fryer basket. The display shows the cooking time and temperature, and the cooking status shows **Cook**.

03 Part way through cooking, the display shows **turn Food**.

 Not applicable to Bake.

If you want to toss or turn your food, remove the air fryer basket and take care of business, then re-insert the basket into the air fryer. Cooking pauses and resumes automatically.

 If your food does not need to be flipped, wait 10 seconds for the program to resume automatically.

04 When the display shows **End**, carefully remove your food from the hot cooking chamber.

CAUTION

The air fryer oven and air frying accessories will be hot during and after cooking. Do not touch hot surfaces with unprotected hands. Allow all items to cool to room temperature, then clean them according to **Care, cleaning and storage** instructions.

Always use proper hand protection and exercise extreme caution when adding or removing food from the hot cooking chamber.

Cooking

Cooking tips

Give all your favorite fresh and frozen oven-baked and deep-fried snacks a fighting chance!

- Preheating is an important step! Wait for the **Add Food** message to appear before adding food to the air fryer basket.
- When baking muffins, buns, quiche, and other treats, use an oven-safe baking dish covered with foil (or an oven-safe lid) to prevent the top from overcooking.
- For coated food, like onion rings or deep-fried pickles, use an egg wash with breadcrumbs rather than liquid-based batters to make sure that batter sticks to the food.
- Spray food items with cooking oil *before* adding seasoning to get the seasoning to stick well.
- For super crispy fries, soak your fresh-cut potato sticks in ice water for 15 minutes, then pat them dry and spray them lightly with oil before cooking.
- Patting dry moist food items before cooking to prevents excess steam and splatter and gives you crispier results.
- Air frying can cause oil and fat to drip from foods. To prevent excess smoke, carefully remove and drain the air fryer basket as needed.

Check out the **cooking timetables**, download the **Instant Pot app**, or visit our **recipe site** for fun, easy-to-follow recipes.

CAUTION

To avoid the risk of fire, property damage and personal injury, DO NOT spray cooking oil into the cooking chamber

CAUTION

When cooking meat, always use a meat thermometer to ensure the internal temperature reaches a safe minimum temperature. Refer to the USDA's **Safe Minimum Internal Temperature Chart** or Health Canada's **Cooking Temperatures Chart** for more information.

Cooking

Reheat

Smart program	Default time	Time range	Default temperature	Temperature range
Reheat	10 minutes (00:10)	1 minute to 1 hour (00:01 to 01:00)	138°C / 280°F	49 to 182°C 120 to 360°F

- 01** Follow steps 01 to 04 in the **Initial test run: Stage 1** to set up the air fryer.
- 02** Remove the air fryer basket and place your food items inside, then carefully re-insert it.
- 03** Touch **Reheat**.
- 04** Touch **Temp**, then turn the dial to adjust the temperature.
- 05** Touch **Time**, then turn the dial to adjust the time.
 -  Smart Programs automatically save adjustments to temperature and time settings when you touch **Start**.
- 06** Touch **Start** to begin reheating.
The time begins to count down right away.
- 07** When the display shows **End**, carefully remove your food from the air fryer.

CAUTION

The air fryer oven and air frying accessories will be hot during and after cooking. Do not touch hot surfaces with unprotected hands. Allow all items to cool to room temperature, then clean them according to **Care, cleaning and storage** instructions.

To avoid a burn injury, always use proper hand protection and exercise extreme caution when adding or removing food from the hot cooking chamber.

Care, cleaning and storage

Clean your air fryer and accessories after each use.

Always unplug the air fryer and let it cool to room temperature before cleaning. Never use harsh chemical detergents, scouring pads, or powders on any of the parts or components.

Let all surfaces dry thoroughly before use, and before storage.

Part or accessory	Cleaning method and notes
Air fryer basket	<ul style="list-style-type: none">• Clean the air fryer basket with a sponge or cloth and warm water and dish soap, then rinse well. Ensure that all grease and food debris are removed.• DO NOT immerse the basket in water or any other liquid.• DO NOT machine wash the basket.
Cooking tray	<ul style="list-style-type: none">• Clean the cooking tray with a cloth or sponge and warm water and dish soap.• The cooking tray has non-stick coating. To avoid damage to the non-stick coating, DO NOT use metal cleaning utensils.
Cooking chamber	<ul style="list-style-type: none">• Clean the cooking chamber with a sponge or soft cloth and warm water and dish soap.• To remove baked-on grease and food residue from cooking chamber, spray with a mixture of baking soda and vinegar and wipe clean with damp cloth.• For stubborn stains, allow the mixture to sit on the affected area for several minutes before scrubbing clean.• Check the heating coil for oil spatter and food debris. Clean the heating coil with a damp cloth as needed. Ensure the heating coil is completely dry before next use.
Exterior	<ul style="list-style-type: none">• Clean with a soft, damp cloth or sponge and wipe dry.

WARNING

To avoid risk of electrical shock and personal injury: <ul style="list-style-type: none">- Do not immerse the appliance in water.- Do not rinse the appliance under a tap.- Do not wet prongs of the power cord.	Without proper cleaning, food and grease splatter may build up around the heating element, causing the risk of smoke, fire, and personal injury.	If you see or smell smoke, touch Cancel , unplug the appliance, and allow it to cool. Remove food splatter or grease with a soft cloth and dish detergent.
--	--	---

Troubleshooting

Register your air fryer today!

If your problem persists or if you have questions, get in touch with a Customer Care Advisor through our chat widget at instantappliances.com/#chat, by email at support@instantappliances.com or by phone at **1-800-828-7280**.

Problem		Possible reason	Solution
Black smoke is coming from the air fryer.	⚠ CAUTION Stop cooking immediately. Cancel the Smart Program, then unplug the air fryer and allow it to cool to room temperature.		
	Using an oil with a low smoke point.	Touch Cancel , unplug the air fryer, and allow it to cool to room temperature. Choose a neutral oil with a high smoke point, such as Avocado, Canola, Soybean, Safflower, or Rice Bran oil.	
	Food residue on the heating coil, in the cooking chamber or on accessories.	Touch Cancel , unplug the air fryer, and allow it to cool to room temperature. Clean the cooking chamber and accessories thoroughly.	
	Faulty circuit or heating element.	Touch Cancel , unplug the air fryer, and allow it to cool to room temperature. Contact Customer Care . Note: Do not attempt to repair the appliance.	
White smoke is coming from the air fryer.	Cooking foods with a high fat content, such as bacon, sausage, and hamburger.	Avoid air frying foods with a high fat content. Check the air fryer basket for excess oil or fat and carefully remove as needed after cooking.	
	Water is vaporizing, producing thick steam.	Pat dry moist food ingredients before air frying and do not add water or other liquid to the cooking chamber when air frying.	
	Seasoning on food has blown into the element.	Be mindful when seasoning food. Spray vegetables and meats with oil before seasoning to help the seasoning stick.	
The air fryer is plugged in but will not turn on.	The appliance is not properly plugged in.	Make sure the power cord is in good condition, and is plugged into the outlet firmly.	
	Outlet is not powered.	Plug another appliance into the same outlet to test the circuit.	
		Plug the air fryer into another outlet.	
Air fryer basket is not fully inserted into the cooking chamber.	Make sure the air fryer basket is fully inserted into the cooking chamber.		
All lights flash and a code appears on the display.	E1	Temperature sensor broken circuit.	Contact Customer Care .
	E2	Temperature sensor short circuit.	Contact Customer Care .

Any other servicing must be performed by an authorized representative.

Warranty

Limited Warranty

This Limited Warranty is effective for one year from the date of original consumer purchase. Proof of original purchase date and, if requested by an authorized representative of Instant Brands Inc. ("Instant Brands"), return of your appliance, is required to obtain service under this Limited Warranty. Provided that this appliance is operated and maintained in accordance with written instructions attached to or furnished with the appliance, Instant Brands will, in its sole and exclusive discretion, either: (i) repair defects in materials or workmanship; or (ii) replace the appliance. In the event that your appliance is replaced, the Limited Warranty on the replacement appliance will expire 12 months from the date of original consumer purchase.

This Limited Warranty extends only to the original purchaser and use of the appliance in the United States of America and Canada. This warranty does not cover units that are used outside of the United States of America and Canada.

Any modification or attempted modification to your appliance may interfere with the safe operation of the appliance and will void this Limited Warranty. This Limited Warranty does not apply in respect of any appliance or any part thereof that has been altered or modified unless such alterations or modifications were expressly authorized by an Instant Brands representative.

Limitation and Exclusions

The liability of Instant Brands, if any, for any allegedly defective appliance or part shall in no circumstances exceed the purchase price of a comparable replacement appliance.

This Limited Warranty does not cover:

1. Damage resulting from accident, alteration, misuse, abuse, neglect, unreasonable use, use contrary to the operating instructions, normal wear and tear, commercial use, improper assembly, disassembly, failure to provide reasonable and necessary maintenance, fire, flood, acts of God or repair by anyone unless directed by an Instant Brands Representative;
2. Repairs where your appliance is used for other than normal, personal use or when it is used in a manner that is contrary to published user or operator instructions; or
3. Use of unauthorized parts and accessories, or repairs to parts and systems resulting from unauthorized repairs or modifications made to this appliance.

The cost of repair or replacement under these excluded circumstances shall be paid by you.

Warranty

Disclaimer of Implied Warranties

EXCEPT AS EXPRESSLY PROVIDED HEREIN AND TO THE EXTENT PERMITTED BY LAW, INSTANT BRANDS MAKES NO WARRANTIES, CONDITIONS OR REPRESENTATIONS, EXPRESS OR IMPLIED, BY STATUTE, USAGE, CUSTOM OF TRADE OR OTHERWISE WITH RESPECT TO THE APPLIANCES OR PARTS COVERED BY THIS WARRANTY, INCLUDING BUT NOT LIMITED TO, WARRANTIES, CONDITIONS, OR REPRESENTATIONS OF WORKMANSHIP, MERCHANTABILITY, MERCHANTABILITY, FITNESS FOR A PARTICULAR PURPOSE OR DURABILITY.

Some states or provinces do not allow for the exclusion of implied warranties of merchantability or fitness, so this limitation may not apply to you. In these states and provinces, you have only the implied warranties that are expressly required to be provided in accordance with applicable law.

Limitation of Remedies; Exclusion of Incidental and Consequential Damage

YOUR SOLE AND EXCLUSIVE REMEDY UNDER THIS LIMITED WARRANTY SHALL BE APPLIANCE REPAIR OR REPLACEMENT AS PROVIDED HEREIN. INSTANT BRANDS SHALL NOT BE LIABLE FOR INDIRECT, INCIDENTAL OR CONSEQUENTIAL DAMAGES ARISING OUT OF OR IN CONNECTION WITH THE USE OR PERFORMANCE OF THE APPLIANCE OR DAMAGES WITH RESPECT TO ANY ECONOMIC LOSS, PERSONAL INJURY, LOSS OF PROPERTY, LOSS OF REVENUES OR PROFITS, LOSS OF ENJOYMENT OR USE, COSTS OF REMOVAL, INSTALLATION OR OTHER INDIRECT, INCIDENTAL OR CONSEQUENTIAL DAMAGES OF ANY NATURE OR KIND.

Warranty Registration

Please visit www.instantappliances.com/support/register to register your new Instant Brands™ appliance and validate your warranty within thirty (30) days of purchase. You will be asked to provide the store name, date of purchase, model number (found on the back of your appliance) and serial number (found on the bottom of your appliance) along with your name and email address. The registration will enable us to keep you up to date with product developments, recipes and contact you in the unlikely event of a product safety notification. By registering, you acknowledge that you have read and understand the instructions for use, and warnings set forth in the accompanying instructions.

Warranty Service

To obtain service under this warranty, please contact our Customer Service Department by phone at 1-800-828-7280 or by email to support@instantappliances.com. You can also create a support ticket online at www.instantappliances.com/support. If we are unable to resolve the problem, you may be asked to send your appliance to the Service Department for quality inspection. Instant Brands is not responsible for shipping costs related to warranty service, save and except for shipping costs associated with the return of your appliance from Canada or within the 48 contiguous states and the District of Columbia of the United States of America, as provided herein. When returning your appliance, please include your name, mailing address, email address, phone number, and proof of the original purchase date as well as a description of the problem you are encountering with the appliance.

Instant™

Instant Brands Inc.

11–300 Earl Grey Dr., Suite 383
Ottawa, Ontario
K2T 1C1
Canada

Register your product today

instantappliances.com/support/register



Contact us

1-800-828-7280
support@instantappliances.com
instantappliances.com/#chat

instantappliances.com
store.instantappliances.com